

Xsight® Lung Tracking Phantom Kit

Models 18023-A,

**QUALITY ASSURANCE AND E2E TESTING
ON CYBERKNIFE® SYSTEMS**

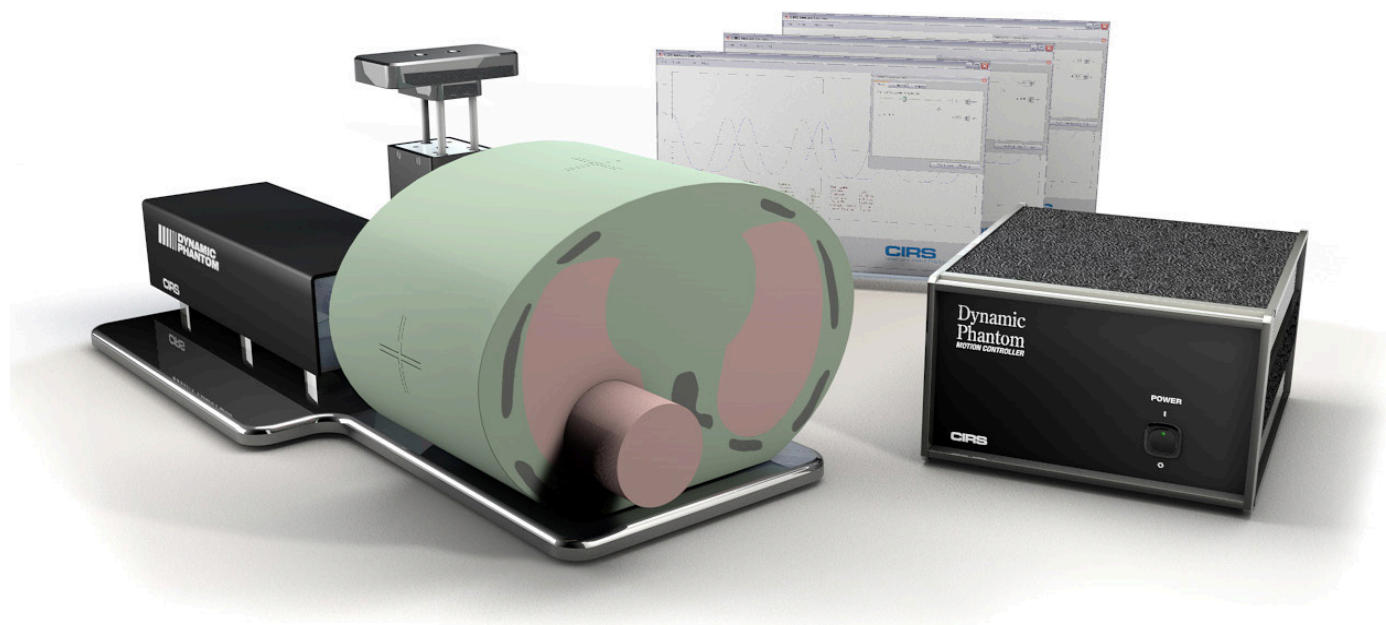

“Strict QA procedures for the imaging, planning and delivery of radiotherapy using respiratory management devices are required to ensure the safe and effective use of test devices.”



AAPM TG-76 report
The management of respiratory motion in radiation oncology

900 Asbury Ave • Norfolk, Virginia 23513 • USA
Tel: 800.617.1177 • 757.855.2765 • Fax: 757.857.0523

WWW.CIRSINC.COM

CIRS

Tissue Simulation & Phantom Technology

Xsight® Lung Tracking Phantom Kit

The CIRS Model 18023-A Xsight Lung Tracking “XLT” Phantom Kit has been verified and validated by Accuray for use with CyberKnife systems and is designed to work in conjunction with the Synchrony System.

The XLT phantom body represents an average human thorax in shape, proportion and composition. It consists of a 3D anthropomorphic spine with cortical and trabecular bone, ribs, and lung lobes. One lung lobe accommodates a lung-equivalent rod containing a film cube with a spherical soft tissue target and dosimetric film. Anthropomorphic spine and ribs provide natural reference structures and challenges for tumor tracking and treatment.

The body is connected to a motion actuator box that induces three-dimensional target motion through linear translation and rotation of the lung-equivalent rod. Motion of the rod itself is radiographically invisible due to its matching density with the surrounding material. The target and its motion, given its density difference, can be resolved.

The phantom shares some components with the CIRS Model 008A Dynamic Thorax Phantom. As with the Model 008A, target and surrogate motion are independently controlled with CIRS Motion Control Software. The graphical user interface provides an unlimited variety of motions while simplifying the operation of the XLT Phantom to an intuitive level. Patient specific profiles are easily imported and there is no need to make hardware adjustments or have special programming skills.

Key differences between the Model 18023-A and the CIRS Model 008A include the length of phantom body, location of the moving rod within the lung, and the inclusion of ribs.

CIRS

Computerized Imaging Reference Systems, Inc is recognized world wide for tissue simulation technology and is the leader in the manufacture of phantoms and simulators for medical imaging and radiotherapy.

www.cirsinc.com

Table of Contents

Easy To Use Software	2
True 3D Target Motion In A Solid Epoxy Phantom	3
Independently Controlled Surrogate Motion	3
Xsight® Lung Phantom Ball Cube Rod	4
Proven Tissue Equivalent Phantom Technology	5
Advanced Electromechanical Components	6
Upgrade Program	6
Model 18023-A Ordering Information	7
Warranty	8
References	8

Easy To Use Software

Dynamic Phantom Motion Control Selection (Thorax or Pelvis)

Graphical user interface simplifies operation of the Model 008A

Adjust motion amplitude, cycle time and phase shift with pull down menus and slider bars

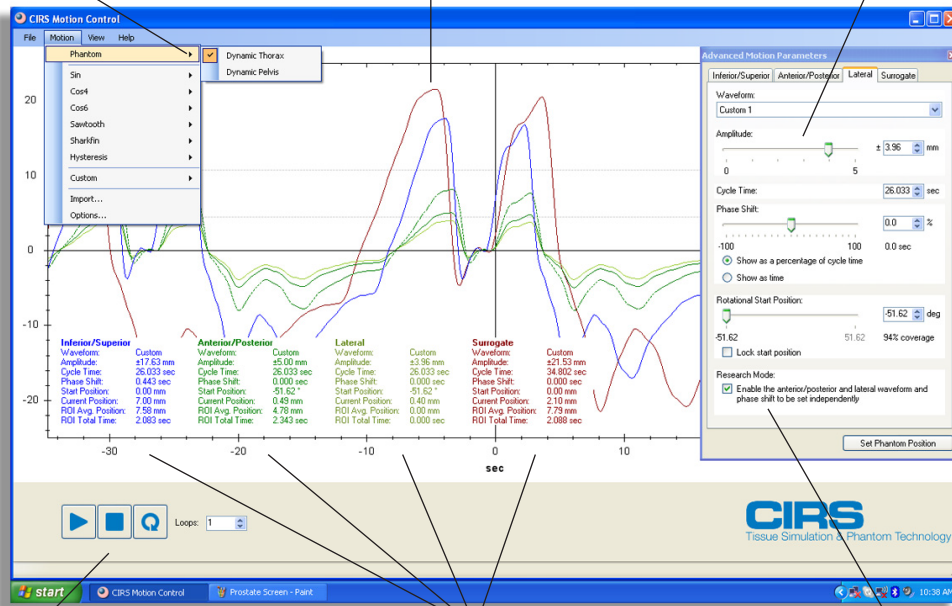

Instantly Start, Stop, Pause or Loop motion

Real-time display of target and surrogate motion parameters

Research Mode to import 3D recorded waveforms

USER FRIENDLY MOTION CONTROL

The Dynamic Phantom is operated using CIRS Motion Control Software Suite, a user-friendly graphical user interface that can be installed on any computer running Windows OS. Upon installation, the user has the option to select the phantom that is to be controlled by the software.

Amplitude, cycle time and phase shift can be applied to both the surrogate and main phantom using slider bars or by entering desired values within the limits of the system. Five different waveforms are available from a standard pull down menu.

An unlimited number of clinically relevant and patient specific waveforms or correlation models can be imported from tab delimited or comma separated file formats, including all main brand name tracking devices available on the market.

There are also waveform editing, smoothing and analyzing tools to ease the optimization of custom waveforms. All motion files can be saved for future use.

The software provides a convenient, real-time graphic display with relevant information about the waveform selected for each direction of simulated tumor. In addition the ROI analyzing function provides the time spent by the target between two chosen amplitudes and the average time weighted position for that particular ROI.

Users can instantly start, stop or pause the motion at any time. New start positions can be graphically selected and applied making the device very useful for static test as well as dynamic testing. Users can also select the number of cycles to be looped by entering the desired value or choose continuous looping (1 million cycles).

The Advanced Motion Parameters window contains a Research Mode that allows researchers to import 3D (x, y, z) recorded waveforms. Once the research mode is selected, the software automatically calculates the best scenario to simulate the real 3D waveform and simulated volume is achieved.

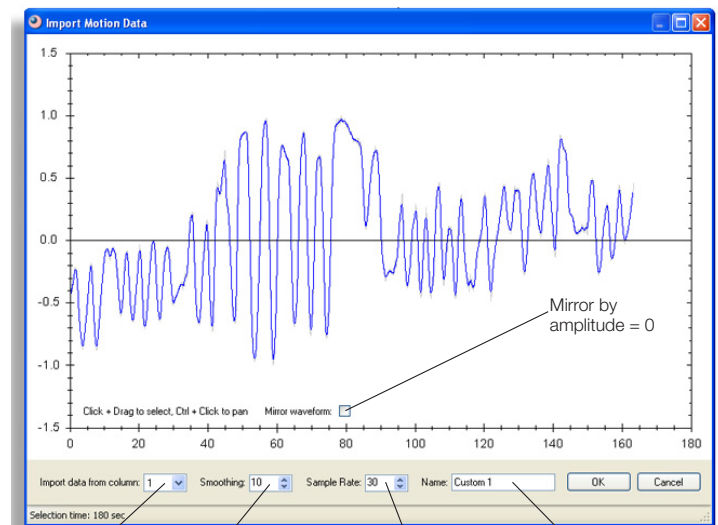

Data Column Selection

Smoothing (Un-smoothed Data = 0; Maximum Smoothing Degree = 100)

Sampling rate of recorded data by Motion Control Software (Used to reconstruct waveform) Range 1 to 100

Name of imported waveform (User or software assigned)

True 3D Target Motion In A Solid Epoxy Phantom

A lung-equivalent solid epoxy rod containing a soft tissue target (and/or dosimeter) is moved within a lobe of similar lung equivalent material in a solid phantom body. Motion of the lung material is radiographically invisible due to its matching density with the surrounding material, however the target can be resolved given its density difference.

The center of the target is positioned off central axis of the rod.

Complex 3D motions can be achieved thru simultaneous, independently controlled linear translation and rotation.

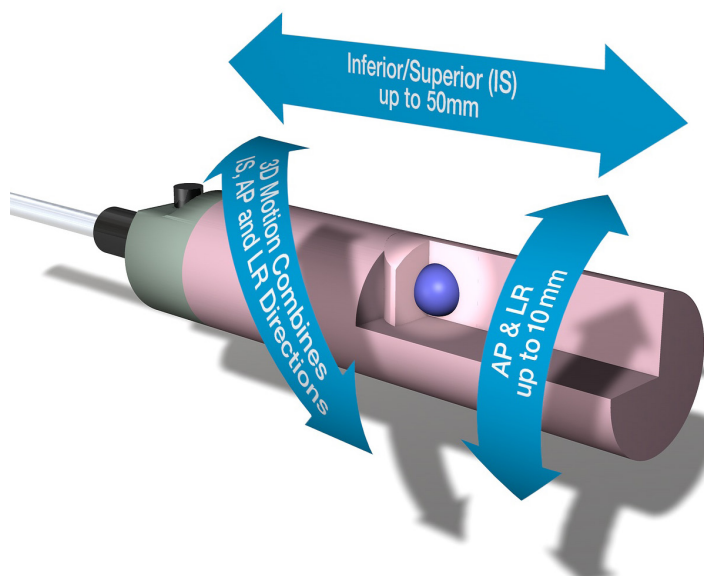
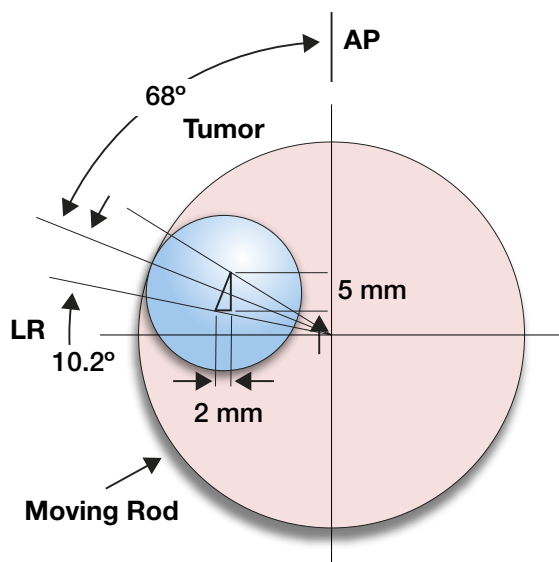

Within the CIRS Motion Control software, the user inputs desired range of target motion in the inferior-superior (IS), anterior-posterior (AP) and the left/right (LR) directions. Using these inputs, the software computes the rotational angles based on known distance of the target center relative to the central axis of the rod. Rotation instruction is sent to the actuator by the software.

- Maximum IS motion is 50 mm
- Maximum AP/LR motion is 10 mm via rotation
- Minimum cycle time is 1 second
- Maximum cycle time is unlimited

Independently Controlled Surrogate Motion

The surrogate motion is mechanically independent of tumor motion and programmable through the CIRS Motion Control Software. The surrogate platform can emulate either chest wall or diaphragmatic motion by manually changing its position. Various gating devices can be attached to the platform. The platform thickness and density allows for CT simulation of the diaphragm. This feature provides even greater

flexibility to the clinician and is useful in assessing correlation between surrogate and tumor motion.

- Maximum surrogate motion 50 mm
- Minimum cycle time is 1 second
- Maximum cycle time is unlimited

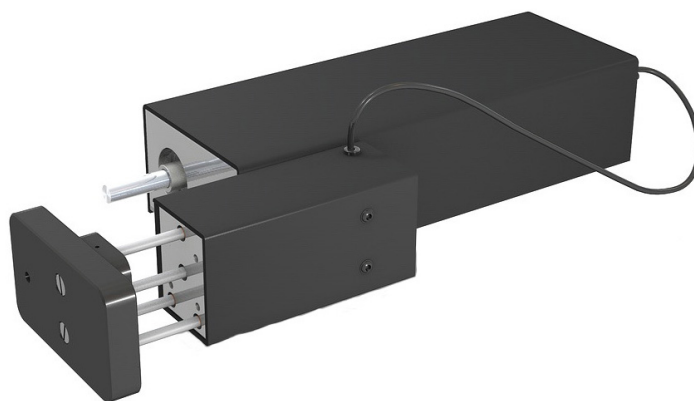
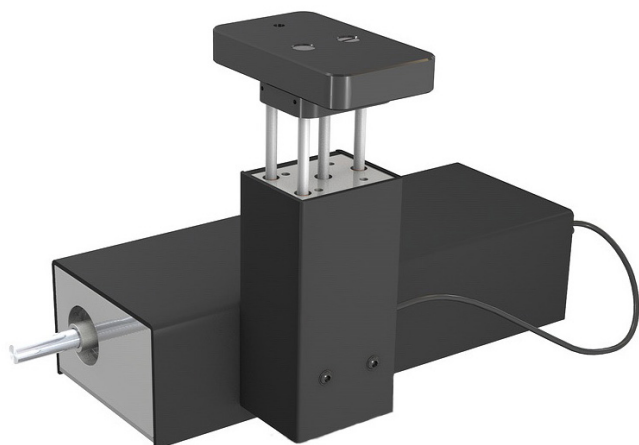

Xsight® Lung Phantom Ball Cube Rod

*Ball cube film sold separately. Contact your local Ashland distributor for more information.

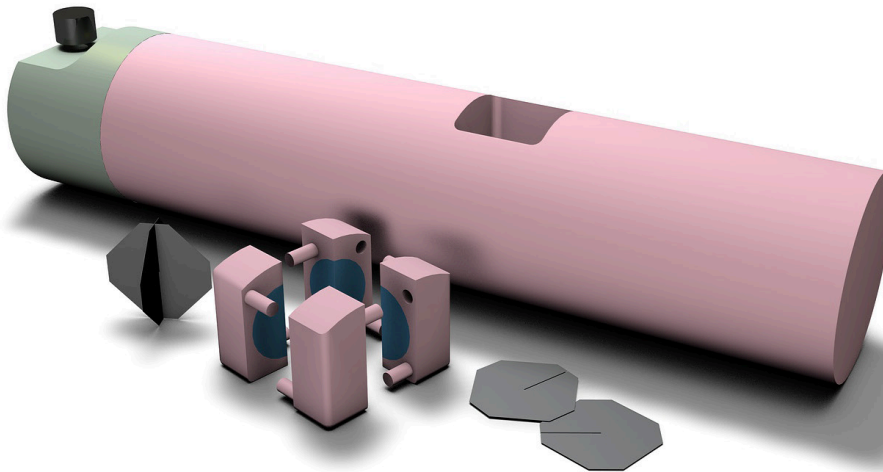

The XLT phantom includes a single dosimeter rod made from lung equivalent epoxy (of respective densities) and measures 63.5 mm in diameter. It contains a 25 mm diameter spherical target that accommodates two pre-cut Radiochromic® films. The rod is easily connected and aligned to the drive shaft.

A film scanner is required for digital film analysis. Accuray recommends using a 16-bit grayscale (or 48-bit color) film scanner with the ability to generate consistent and accurate optical density and position measurements. Instructions for use of either phantom and E2E test film analysis software are provided by Accuray.

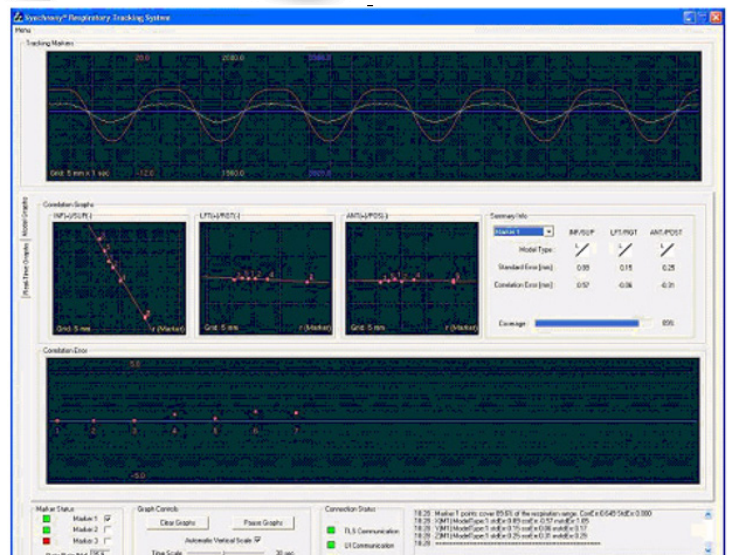

Synchrony System displaying the detected phantom motion

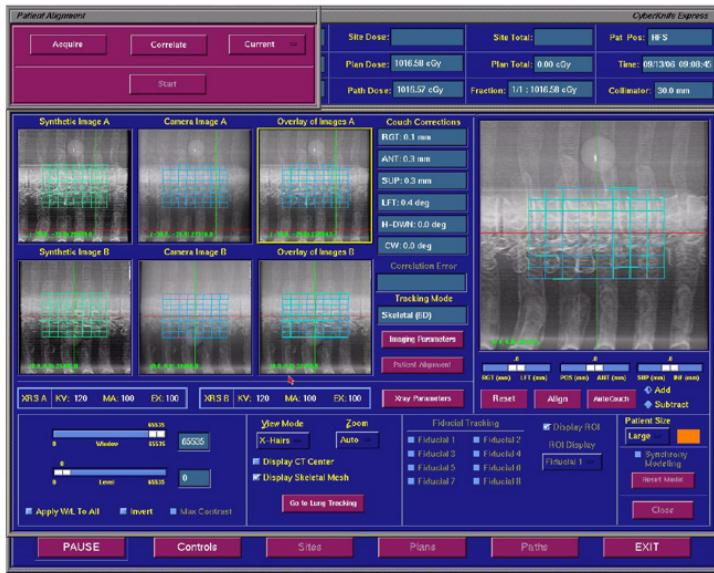

Using Xsight Spine Tracking System for initial phantom alignment

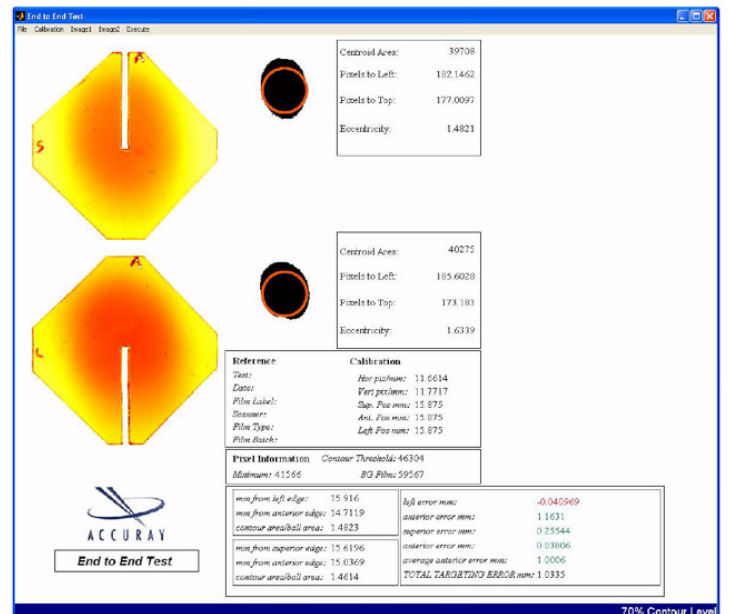

E2E software analysis of the films used in the Xsight Lung Tracking System Phantom

Proven Tissue Equivalent Phantom Technology

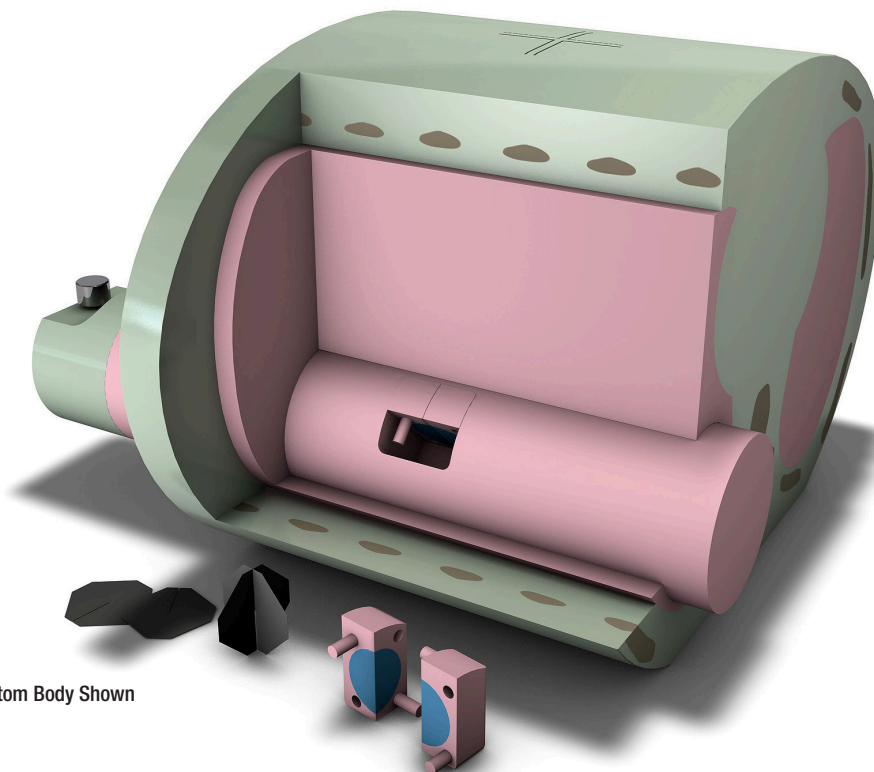

XLT Phantom Body Shown

The XLT phantom approximates the average human thorax in both size and structure using simplified geometries. The phantom body contains ribs and a 3D anthropomorphic spine with cortical and trabecular bone.

The phantom is constructed of proprietary tissue equivalent epoxy materials with linear attenuations within 1% of actual attenuation for water and bone and within 3% for inhale lung from 50 keV to 15 MeV. This allows using the phantom for end-to end (E2E) testing starting from CT without additional CT number adjustment. If treatment planning system (TPS) requests users to enter material data, electron density should be used instead of physical density of resins.

External alignment marks facilitate rapid orientation with positioning lasers and phantom image registration.

Material	Density, g/cc	Electron Density X 10 ²³ , per cc	Ratio to H ₂ O
Plastic Water® DT	1.04	3.35	1.003
XLT Lung	0.21	0.69	0.207
Cortical Bone	1.91	5.95	1.782
Trabecular Bone	1.20	3.86	1.156
Soft tissue target	1.06	3.43	1.028
4 DP Lung	0.71	2.32	0.695

Linear Attenuation Coefficients To Reference Tissues ^{(3) (4)}				
	Plastic Water® DT	Trabecular Bone	Cortical Bone	XLT Lung (Inhale)
En, MeV	Ratio, %	Ratio, %	Ratio, %	Ratio, %
0.04	100.8	100.0	100.00	100.3
0.06	100.5	100.1	100.00	101.1
0.08	100.3	100.3	99.99	101.9
0.10	100.2	100.3	99.99	102.2
0.15	100.0	100.4	100.0	102.5
0.20	100.1	100.5	99.99	102.5
0.40	100.1	100.5	100.0	102.7
0.60	100.1	100.5	100.0	102.6
0.80	100.1	100.4	100.0	102.7
1.00	100.1	100.5	100.0	102.7
1.50	100.1	100.5	100.0	102.7
2.00	100.1	100.5	99.99	102.6
4.00	100.0	100.5	99.92	102.1
6.00	99.8	100.3	99.85	101.6
8.00	99.7	100.0	99.79	101.2
10.0	99.6	100.0	99.73	100.7
15.0	99.2	99.78	99.61	100.0
20.0	99.1	99.58	99.55	102.7

3. ICRP 23, Report of the Task Group on Reference Man (1975).

4. Woodard, H.Q., White, D.R., *The Composition of Body Tissues*, The British Journal of Radiology (1986) 59: 1209-1219

Advanced Electromechanical Components

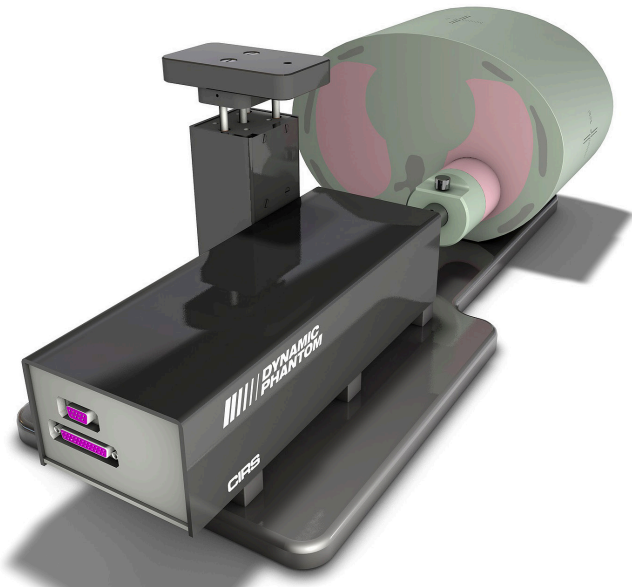

ACTUATOR

Housed within anodized aluminum enclosures, the actuator contains bipolar stepper motors that enable linear motion accuracy of 0.05 mm and rotational motion accuracy of 0.2°. Linear motion of the target in the (IS) direction can be isolated from rotational motion in the axial plane in both frequency and amplitude. Surrogate motion is independently controlled. Motions can be synchronized to one another with accuracy better than 20 msec. Motion cycle time accuracy is better than 5 msec. Optical sensors ensure precise mechanical positioning. The actuator is designed for continuous operation. If not manually stopped and reset by the user, it will perform 1000000 (in continuous mode) cycles then stop automatically.



CONTROLLER

Motions are generated through a three-axis motion controller. A USB port enables interfacing with most computers. The controller sends instructions as well as supplies and conditions power to the actuator thru a 25 pin serial cable.

The motion controller can be fully operated through CIRS Motion Control Software (see page 3) from a distance of up to 70 feet with the Ethernet/USB cable provided.

Upgrade Program

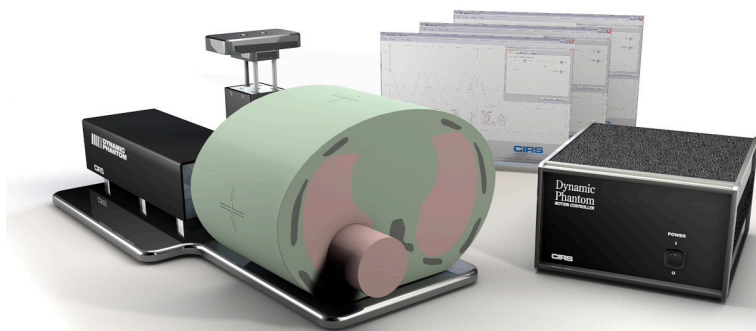

The original Model 18023 Xsight Lung Tracking Phantom Kit (Accuray Part No. 025190) can be upgraded to the Model 18023-A. Upgraded features include: 3-axis controller, independently controlled linear, rotational and surrogate motion and CIRS Motion Control Software, a user-friendly graphical user interface that can be installed on any computer running Windows XP or later.

Motion profiles validated by Accuray and provided in the original Model 18023 and Accuray Part No. 025190 can be easily set-up to run along with standard options. An unlimited number of clinically relevant and patient specific waveforms or correlation models can also be imported from vendor specific, tab delimited or comma separated file formats.

Model 18023-A

Ordering Information

INCLUDED WITH MODEL 18023-A

Qty	Component Description
1	XLT Torso (Phantom Length 18cm)
1	Gating Device Assembly
1	Motion Controller
1	Base Plate
3	Spacers for Phantom
1	Actuator Assembly
1	CIRS Motion Control Software (USB Key)
1	XLT - Target Moving Rod
1	XLT - Film Cube #3*
4	Replacement Assembly Pins for Cube #3
2	Screwdriver, 4 -in- 1
1	Push Rod for ball cube
1	Wrench, Hex, 3/32"
1	Wrench, Hex, 5/64"
2	2 amp fuses
1	Extra fasteners (pack)
1	XLT Kit Case (67 cm x 32 cm x 28 cm; 18.5 kg shipping weight)

*Ball cube film sold separately. Contact your local Ashland distributor for more information.

SPECIFICATIONS

Power:	110-250 VAC, 50/60 Hz
Amplitude, IS:	± 25 mm
Amplitude, AP/LR:	± 5 mm
Amplitude, Surrogate:	± 25 mm
Max. Surrogate Platform Load	5.4 kg (12 lb)
Motion Accuracy:	± 0.1 mm
Cycle Time:	1 - ∞ (adjusted based on amplitude)
Waveforms:	sin (t), 1-2cos4(t), 1-2cos6(t), sawtooth, sharkfin
CIRS Motion Control Software System Requirements	Windows XP® / Vista / Windows 7 / Windows 8 / Windows 10 (32 or 64 bit) Pentium 3® or equivalent 512 MB RAM 2 MB of available disk space

Limited Warranty

All standard CIRS products and accessories are warranted by CIRS against defects in material and workmanship for a period as specified below. During the warranty period, the manufacturer will repair or, at its option, replace, at no charge, a product containing such defect provided it is returned, transportation prepaid, to the manufacturer. Products repaired in warranty will be returned transportation prepaid.

There are no warranties, expressed or implied, including without limitation any implied warranty of merchantability or fitness, which extend beyond the description on the face hereof. This expressed warranty excludes coverage of, and does not provide relief for, incidental or consequential damages of any kind or nature, including but not limited to loss of use, loss of sales or inconvenience. The exclusive remedy of the purchaser is limited to repair, recalibration, or replacement of the product at manufacturer's option.

This warranty does not apply if the product, as determined by the manufacturer, is defective because of normal wear, accident, misuse, or modification.

NON-WARRANTY SERVICE

If repairs or replacement not covered by this warranty are required, a repair estimate will be submitted for approval before proceeding with said repair or replacement.

PRODUCT	WARRANTY PERIOD
Models 18023-A - Dynamic Phantom	24 Months

References:

Munoz, C., et al., Evaluation of Positional Accuracy in Moving Tumors Using a CIRS Dynamic Phantom. Poster presented, Cyberknife User's Meeting January 2007.

Tanyi, James, A., et al., Phantom investigation of 3D motion-dependent volume aliasing during CT simulation for radiation therapy planning. Radiation Oncology, 2007, 2:10.
Chuang, C., et al., The use of a new dynamic motion phantom for patient specific QA in tracking therapy. 2006 AAPM Abstract ID No. 4639.

Wang, Z., et al., Verifying Internal Target Volume using Cone-Beam CT for Stereotactic Body Radiotherapy Treatment. 2006 AAPM Abstract ID No. 5263, Poster #: SU-EE-A1-4.

Tanyi, James, A., et al., Dosimetric Evaluation of Target Dose in Stereotactic Body Radiation Therapy (SBRT) of Lung Lesions Using a Dynamic Motion Anthropomorphic Phantom. 2004 AAPM PO-T-143 Poster.

Tanyi, James, A., et al., Phantom Investigation of Three-Dimensional, Motion-Induced Dose Discrepancy During Intensity Modulated Radiation Therapy Dose Delivery. Poster presented at 2006 annual AAPM meeting, Orlando FL, July 2006.

Tanyi, James, A., et al., Phantom Investigation of Three-Dimensional Motion Dependent Volume Aliasing During CT Simulation for Radiation Therapy Planning. Poster presented at 2006 annual AAPM meeting, Orlando FL, July 2006.

Varchena, V., et al., A novel Dynamic Thorax phantom for 3D-CRT and IMRT of lung lesions. Radiotherapy & Oncology at Meeting, Vol. 76, Supplement 2, September 2005.

CIRS

COMPUTERIZED IMAGING REFERENCE SYSTEMS, INC.

900 Asbury Ave
Norfolk, Virginia 23513 USA

Toll Free: 800.617.1177

Tel: 757.855.2765

Fax: 757.857.0523

E-mail admin@cirsinc.com

www.cirsinc.com

Technical Assistance

1.800.617.1177



Computerized Imaging Reference Systems, Inc. has been certified by UL DQS Inc. to **(ISO) 13485:2016**. Certificate Registration No.10000905-MP2016.

©2016 Computerized Imaging Reference Systems Inc.
All rights reserved. All brand names, product names or trademarks belong to their respective holders.
Specifications subject to change without notice.
Publication: 18023-A PB 060222